

Modulo NFR Timber Doorset

Product Datasheet



NFR Configurations

Single Doorset

Latched, Single Action, Single Doorset (LSASD)
Unlatched, Single Action, Single Doorset (ULSASD)

Double Doorset

Latched, Single Action, Double Doorset (LSADD)
Unlatched, Single Action, Double Doorset (ULSADD)

Acoustic Rating

ModuCore BB with Dropseal fitted **Up to 30dB** (Single doorset only)

ModuCore TC n/a





ModuCore HC n/a

Door Weights

ModuCore BB (44mm) **24.5 kg/m²**

ModuCore TC (44mm) **21.97 kg/m²**

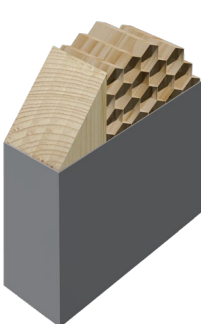
ModuCore HC (44mm) **8.62 kg/m²**

| Door Leaves | ModuCore BB (Stock) | ModuCore TC (Purchase To Order) | ModuCore HC (Purchase To Order) | ModuCore PB (Purchase To Order) |
|-----------------|---|--|--|---|
| Minimum Height | 1000mm | 1981mm (Imperial) / 2040mm (Metric) | | |
| Maximum Height | 2040mm | 1981mm (Imperial) / 2040mm (Metric) | | |
| Standard Widths | 326, 426, 457, 492, 526, 533, 560, 592, 610, 626, 660, 692, 711, 726, 762, 792, 810, 826, 838, 861, 892, 914, 926mm | 457, 533, 610, 686, 711, 762, 813, 838, 864, 914mm (Imperial) 426, 526, 626, 726, 826, 926mm (Metric) | | |
| Door Core |  |  |  |  |
| Construction | Solid timber blockboard core with MDF facings and ABS Edge-banding | Tubular core with MDF facings, timber sections to perimeter ABS Edge-banding | Honeycomb core with MDF facings, timber sections to perimeter ABS Edge-banding | Particle board with MDF facings and ABS Edge-banding |

Door Leaf Finishes - Please see end of Datasheet

Modulo NFR Timber Doorset

Product Datasheet

Frame Options

85mm wide

To suit wall thickness from 73mm to 100mm

ModuFrame BB (Blockboard)
NFR

(ModuFrame MDF Purchase To Order)

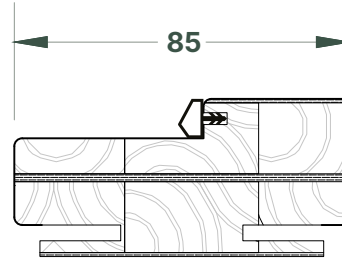

100mm wide

To suit wall thickness from 88mm to 115mm

ModuFrame BB (Blockboard)
NFR

(ModuFrame MDF Purchase To Order)

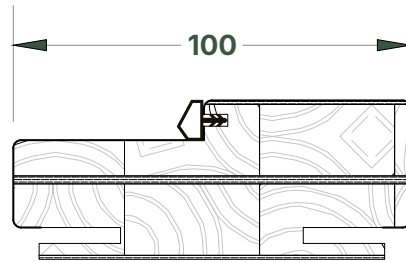

120mm wide

To suit wall thickness from 108mm to 135mm

ModuFrame BB (Blockboard)
NFR

(ModuFrame MDF Purchase To Order)

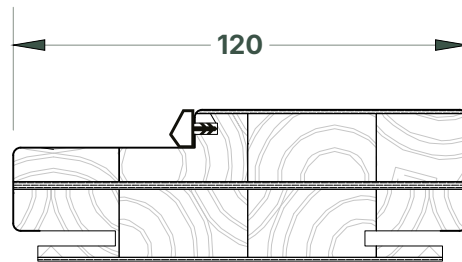

140mm wide

To suit wall thickness from 128mm to 155mm

ModuFrame BB (Blockboard)
NFR

(ModuFrame MDF Purchase To Order)

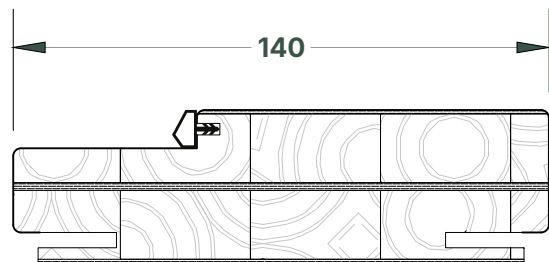

Drawings not to scale

Frame Finishes

Stock

RTP

Ready to Paint

Purchase To Order

CPL Laminate

Light Oak

Mid Oak

Chalk White

Slate Grey

Modulo NFR Timber Doorset

Product Datasheet

Architrave **Quadrant**

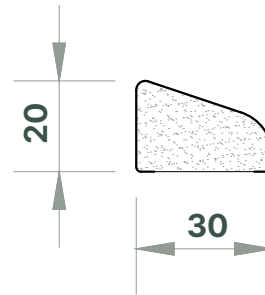
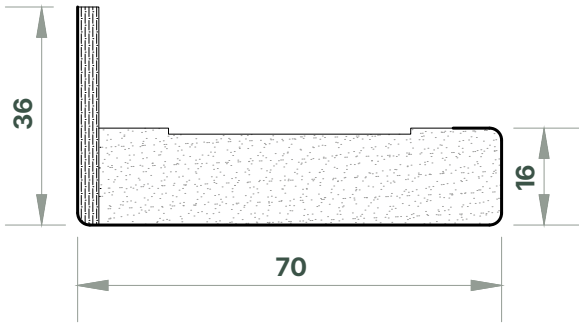

Drawings not to scale

Extension Linings

60mm wide
MDF

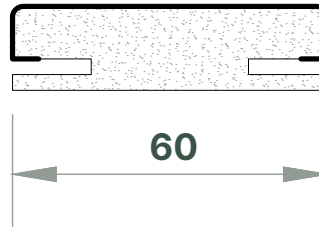

80mm wide
MDF

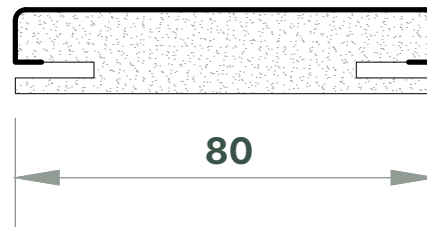

100mm wide
MDF

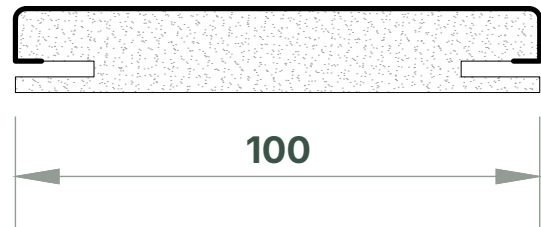

Drawings not to scale

Architrave, Quadrant & Extension Lining Finishes

| | |
|-------------------|---|
| Stock | RTP <input type="radio"/> Ready to Paint |
| Purchase To Order | CPL Laminate <input type="radio"/> Light Oak <input type="radio"/> Mid Oak <input type="radio"/> Chalk White <input type="radio"/> Slate Grey |

Modulo NFR Timber Doorset

Product Datasheet

| Ironmongery | Description | Part No. |
|-----------------------------|---|---|
| Hinges | 102 × 76mm G13 SSS BB Butt Hinge Rad Corners | SEL-PRT-01766 |
| Closers | Overhead Door Closer EN3 Overhead Door Closer EN2-4 BC EN2-4 Scissor Arm Closer +Backcheck Function (Satin Nickel) EN2-4 Scissor Arm Closer +Delayed Action & Backcheck (Silver) EN2-5 Scissor Arm Closer Basic (Satin Nickel) EN2-5 Scissor Arm Closer +Delayed Action & Backcheck (Satin Nickel) Electromag Hold Open Closer Responder24 EN4 (Satin Nickel) EN2-4 Cam Action Slide Arm Closer (Satin Nickel) Pair EN2-4 & EN3 Scissor Arm Closer Basic (Satin Nickel) | SEL-PRT-02574 SEL-PRT-02575 SEL-PRT-02575 TBC SEL-PRT-02577 SEL-PRT-02576 SEL-PRT-02568 SEL-PRT-02647 SEL-PRT-02575 & SEL-PRT-02574 |
| Latches/Locks | DIN Standard Mortice Latch DIN Standard Mortice Sashlock DIN Standard Mortice Deadlock DIN Standard Mortice Bathroom Lock 76mm Tubular Latch Mechanical Codelock with lever handle | SEL-PRT-02244 SEL-PRT-02248 SEL-PRT-02246 SEL-PRT-02245 SEL-PRT-02133 SEL-PRT-02633 |
| Lever handles | 19mm RTD SSS Levers on Round Rose | SEL-PRT-02542 |
| Pull handles | 425 × 19mm SSS B/F 'D' Pull Handle Customers own (subject to approval) | SEL-PRT-02034 N/A |
| Pushplate | 500 × 90mm SSS Finger Plate Sq Corners | SEL-PRT-02044 |
| Kickplate | 200mm high x 1.2mm SSS Kickplate Sq Corners (to suit door width) | SEL-PRT-02023 - XXXX |
| Cylinders | 70mm SC Euro Double Cylinder KD 70mm SC Euro Cylinder & Thumbturn KD | SEL-PRT-01247 SEL-PRT-01409 |
| Escutcheons | 52 × 8mm SSS Euro Profile Escutcheon 52 × 8mm SSS Blank Escutcheon Euro Cylinder Pull SSS | SEL-PRT-02048 SEL-PRT-02050 SEL-PRT-02253 |
| Bathroom indicator | 52 × 8mm SSS Disabled Turn & Release with Indicator | SEL-PRT-02051 |
| Flushbolts | 200 × 20mm SSS Lever Action Flush Bolt Rad End | SEL-PRT-01995 |
| Air transfer grills (pairs) | Air Transfer Grill - 300×300mm (NFR) Air Transfer Grill - 350×350mm (NFR) Air Transfer Grill - 400×400mm (NFR) | SEL-PRT-02515 SEL-PRT-02516 SEL-PRT-02517 |
| Signage | 76mm Dia' Disabled Symbol 76mm Dia' Female Symbol 76mm Dia' Male Symbol 76mm Dia' Unisex Symbol 76mm Dia' WC Symbol 76mm Numeral Self-Adhesive. 0-9 and A, B & C | SEL-PRT-02566 SEL-PRT-02569 SEL-PRT-02572 SEL-PRT-02579 SEL-PRT-02580 SEL-PRT-02119 - SEL-PRT-02131 |
| Door stop | Pedestal Floor Doorstop | SEL-PRT-02556 |
| Dropseal | Concealed Dropseal (to suit door width) | SEL-PRT-02497 - SEL-PRT-02507 |

As standard, ironmongery is 'Satin Stainless Steel' style.

Vision Panels

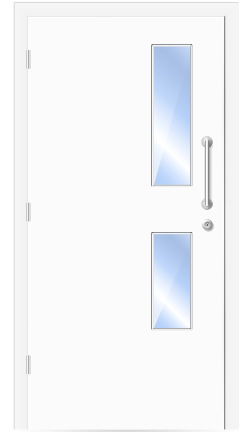
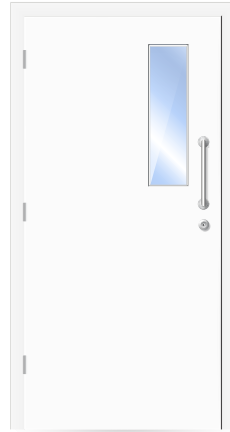

| | | | |
|--------------|--|-----------|-----------------------|
| Reference | Type A | Type B | Type C |
| Clear vision | 1470×170mm | 745×170mm | 745×170mm & 495×170mm |
| Glass | 6.4mm clear laminated | | |
| Margins | 150mm of margin to top and leading edge of door leaf | | |
| Finish | Lacquered Oak - Used in all finished laminate door leaves White Primed - Used in RTP door leaves | | |

Threshold (If required)

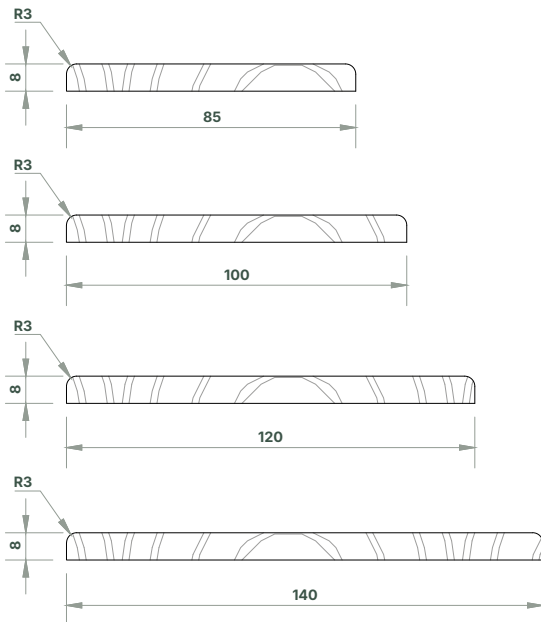

8mm thick
Hardwood, flat strip with width to suit frame

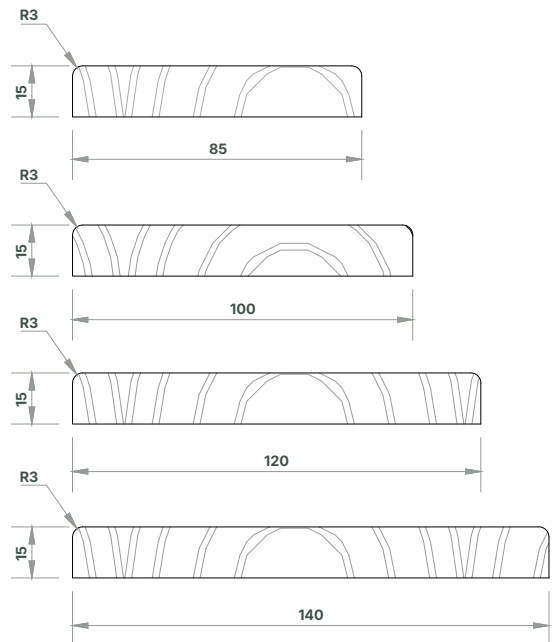

Drawings not to scale

15mm thick
Hardwood, flat strip with width to suit frame

Modulo NFR Timber Doorset

Product Datasheet

| Door Leaf Finishes | Moducore BB (Stock) | Purchase To Order |
|---|---|---|
| Ready to Paint | <input type="radio"/> Matt Paper | <input type="radio"/> Matt Paper |
| White Laminate Melamine faced MDF | <input type="radio"/> Chalk White | Formica / Egger / Greenlam Laminates (To customer specification) |
| Wood Grain Laminate/Veneer Melamine faced MDF | <input type="radio"/> Light Oak <input type="radio"/> Mid Oak | Formica / Egger / Greenlam Laminates / Real-wood Veneers (To customer specification) |
| Solid Colour Laminate Melamine faced MDF | <input type="radio"/> Slate Grey | Formica / Egger / Greenlam Laminates (To customer specification) |